

# BASIC INFORMATION

LOCATOR® Attachment System  
for Straumann® Implants



# 1. THE LOCATOR® ATTACHMENT SYSTEM FOR REMOVABLE OVERDENTURES

The LOCATOR Attachment System for removable overdentures offers an excellent long-term performance thanks to the high wear resistance of the components and the resilient connection of the prosthesis. The self-locating design of the LOCATOR components enables the patient to easily seat the prothesis.

The LOCATOR attachment is designed to require minimum of vertical space, while overcoming implant divergence of up to 40° between two implants. The LOCATOR abutments are made out of TAV, have a TiN coating that provides increased protection against wear, and are available in six different gingiva heights.

## 1.1 THE LOCATOR ATTACHMENT SYSTEM AT A GLANCE

- Innovative pivoting technology
- Self-aligning design
- Low vertical height
- Compensation of implant divergences up to 40° between two implants
- Exceptional durability

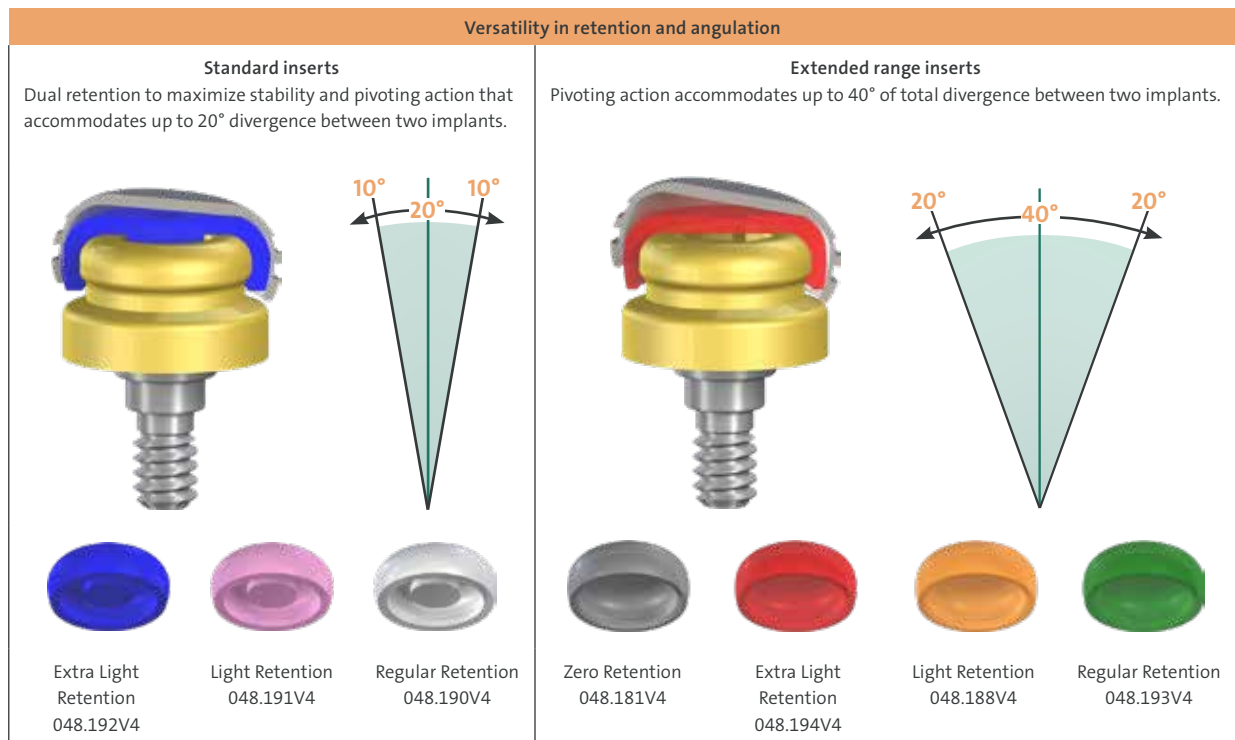

## 1.2 OVERVIEW OF THE LOCATOR® ABUTMENT AND ATTACHMENT DIMENSIONS

### LOCATOR Attachment dimensions

	A	H
LOCATOR Attachment	2.25	1.5



### TL, TLX LOCATOR Straight Abutment Dimensions

		B	C
TL: RN, NNC	LOCATOR H 1 mm	1.0	2.5
	LOCATOR H 2 mm	2.0	3.5
	LOCATOR H 3 mm	3.0	4.5
	LOCATOR H 4 mm	4.0	5.5
	LOCATOR H 5 mm	5.0	6.5
	LOCATOR H 6 mm	6.0	7.5
TL: WN	LOCATOR H 1 mm	1.0	2.5
	LOCATOR H 2 mm	2.0	3.5
	LOCATOR H 3 mm	3.0	4.5
	LOCATOR H 4 mm	4.0	5.5
	LOCATOR H 5 mm	5.0	6.5
TLX: NT	LOCATOR H 1 mm	1.2	2.7
	LOCATOR H 2 mm	2.2	3.7
	LOCATOR H 3 mm	3.2	4.7
	LOCATOR H 4 mm	4.2	5.7
	LOCATOR H 5 mm	5.2	6.7
TLX: RT	LOCATOR H 1 mm	1.4	2.9
	LOCATOR H 2 mm	2.4	3.9
	LOCATOR H 3 mm	3.4	4.9
	LOCATOR H 4 mm	4.4	5.9
	LOCATOR H 5 mm	5.4	6.9
TLX: WT	LOCATOR H 1 mm	1.6	3.1
	LOCATOR H 2 mm	2.6	4.1
	LOCATOR H 3 mm	3.6	5.1
	LOCATOR H 4 mm	4.6	6.1
	LOCATOR H 5 mm	5.6	7.1
	LOCATOR H 6 mm	6.6	8.1

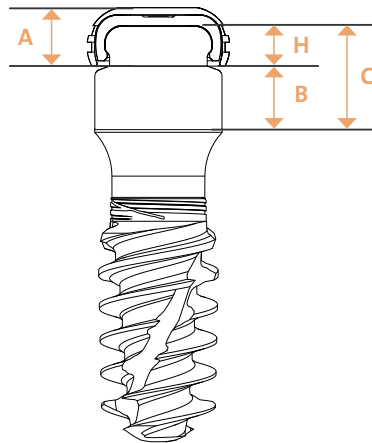

### BL, BLX LOCATOR® Straight Abutment Dimensions

		GH	C
BLX: RB, WB	LOCATOR GH 1.5 mm	1.5	3
	LOCATOR GH 2.5 mm	2.5	4
	LOCATOR GH 3.5 mm	3.5	5
	LOCATOR GH 4.5 mm	4.5	6
	LOCATOR GH 5.5 mm	5.5	7
	LOCATOR GH 6.5 mm	6.5	8
BL: NC, RC	LOCATOR GH 1 mm	1.0	2.5
	LOCATOR GH 2 mm	2.0	3.5
	LOCATOR GH 3 mm	3.0	4.5
	LOCATOR GH 4 mm	4.0	5.5
	LOCATOR GH 5 mm	5.0	6.5
	LOCATOR GH 6 mm	6.0	7.5

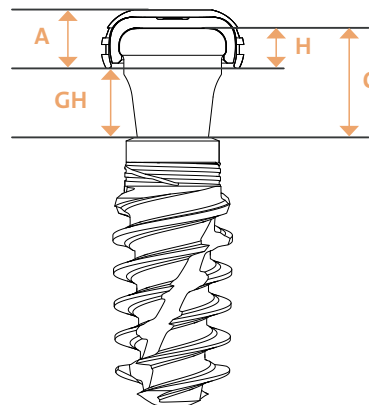

### 1.3 THE LOCATOR® 3-IN-1 CORE TOOL

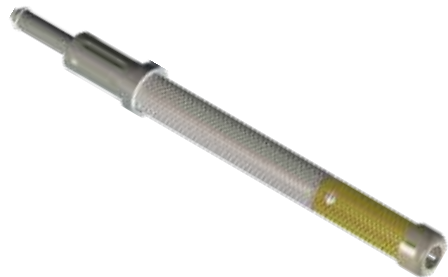

**LOCATOR Core Tool**  
assembled



**LOCATOR Core Tool**  
disassembled

1

#### REMOVAL

The Removal Tool has a sharp edge on the end to engage and remove the Insert from the Denture Cap.

2

#### SEATING

The Seating Tool is used to seat the LOCATOR Inserts.

3

#### PLACEMENT

The Abutment Driver with the Abutment Holder Sleeve carries the Abutment securely and places it onto the implant.

## 1.4 USING THE LOCATOR® CORE TOOL

Loosen the Removal end of the Core Tool a full three turns counterclockwise (you will see a visible gap).

**REMOVING THE BLACK PROCESSING INSERT FROM THE DENTURE CAP:** Insert the tip into the Denture Cap Assembly and push straight into the bottom of the Male. Tilt the tool so that the sharp edge of the tip will engage with the Black Processing Insert and pull it out of the Denture Cap.

**DISENGAGING THE BLACK PROCESSING INSERT FROM THE REMOVAL TIP OF THE CORE TOOL:** Point the tool down and away from you and tighten the Removal Tool clockwise back onto the Core Tool. This will activate the removal pin and disengage the Black Processing Insert from the tip of the Removal Tool.

**PLACING THE LOCATOR INSERTS:** Separate The Removal Tool section from the Core Tool and use the Seating Tool end to place a new Insert into the empty Denture Cap.

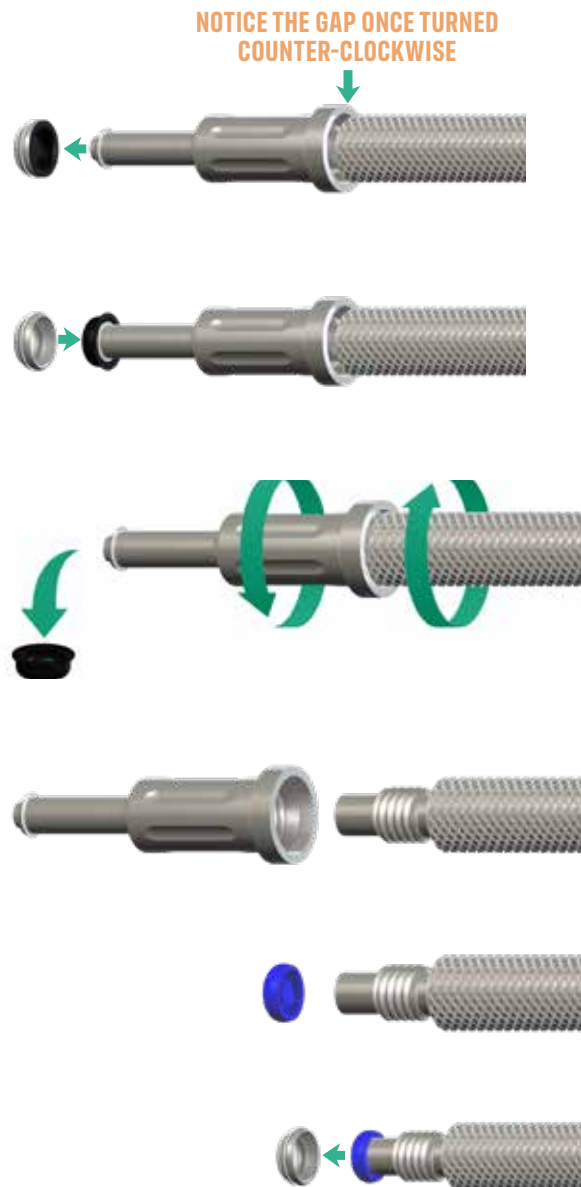

# 2. CREATING AN OVERDENTURE WITH THE LOCATOR<sup>®</sup> ATTACHMENT SYSTEM

## 2.1 SELECTING AND PLACING THE LOCATOR ABUTMENT



### Step 1:

Use the angle measurement guide to determine the angulation of each implant. Select the LOCATOR standard inserts for implants with 10° of divergence or less, and the LOCATOR extended range inserts for implants with greater than 10° and less than 20° of divergence.

**Note:** Please refer to the *LOCATOR Retention Inserts* section on page 14.



### Step 2:

Remove the healing abutments.

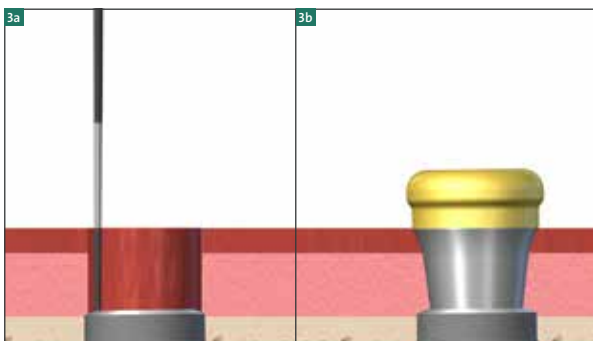

### Steps 3a and 3b:

Using a periodontal probe, measure the height of the gingiva at the highest point and select the cuff height of the LOCATOR Abutment that corresponds to that measurement. If it is 2 mm, choose a 2 mm cuff height.

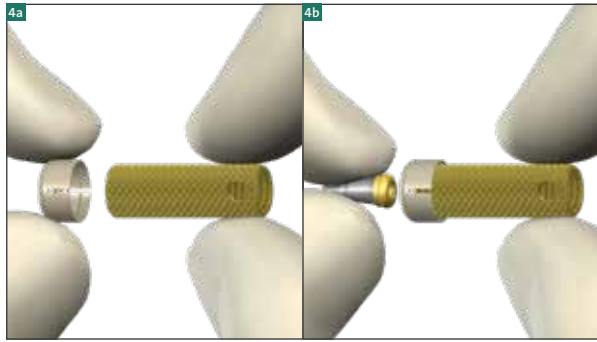

**Steps 4a and 4b:**

Slide the Abutment Holder Sleeve onto the abutment driver portion of the LOCATOR® 3-in-1 Core Tool. Place the LOCATOR Abutment selected for each implant into the Abutment Holder Sleeve.

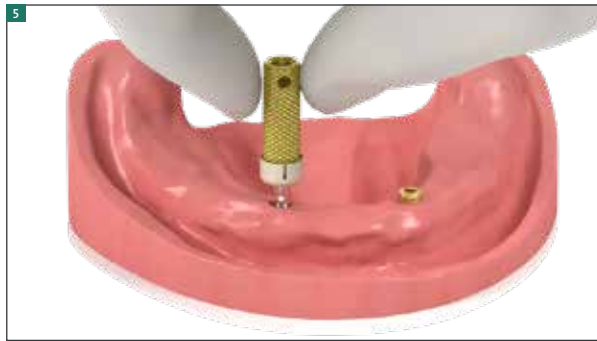

**Step 5:**

Screw the LOCATOR Abutment into the implant and hand tighten. Radiograph each interface to confirm that the Abutments are fully seated on the implants. Place the film perpendicular to the interface.



**Step 6:**

Hand tighten the abutment with the LOCATOR driver. Then torque the abutment to 35 Ncm using the Straumann® Ratchet with Torque Control Device and LOCATOR Driver.

**Warning:** Use of higher torque values than recommended could cause a fracture of the LOCATOR Abutment.

A direct or indirect technique may be used for processing the Denture Cap in the overdenture. Please refer to page 6 for the direct technique and page 9 for the analog indirect technique and page 11 for the digital indirect technique.

## 2.2 PROCESSING LOCATOR® DENTURE CAPS INTO THE OVERDENTURE: DIRECT TECHNIQUE



### Step 1:

Place a White Block-Out Spacer around each abutment and press it down to the tissue. Snap a Denture Cap with a pre-assembled Black Processing Insert onto each abutment, pressing down firmly.



### Step 2:

Apply fit check marking paste to the intaglio surface of the overdenture. Insert it into the mouth in position over the LOCATOR Denture Cap. This will mark areas where the overdenture will need to be relieved to allow space for the Denture Caps to be picked up.



### Step 3:

Hollow out the existing denture base in the areas of the LOCATOR Denture Caps with Handpiece and resin bur. There should be sufficient space around the Denture Cap to allow for sufficient thickness of the self-polymerizing resin.

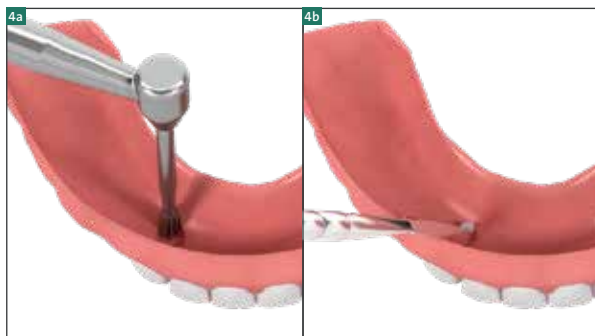

### Steps 4a and 4b:

Cut an undercut around the circumference of the recesses for mechanical retention. Cut lingual/palatal vent windows in the overdenture with a thin bur to visualize full seating and for excess material to vent.



**Step 5:**

Dry the Denture Caps. Apply a small amount of self-curing acrylic resin around the circumference of each Denture Cap. Apply the same material into the recesses in the overdenture and seat it over the Denture Caps and onto the soft tissue. Have the patient close into light occlusion and hold while the material sets.

**Note:** Excessive occlusal pressure during the setting time may cause tissue recoil against the overdenture base and could contribute to dislodging and premature wear of the LOCATOR Retention Inserts.

**Step 6:**

Disengage the overdenture from the Abutments and remove from the mouth. Verify that the Denture Caps have been securely processed into the overdenture. Fill any voids with acrylic resin.

**Step 7:**

Remove any excess acrylic material remaining on the overdenture and finish the overdenture.

**Step 8:**

Remove the Black Processing Insert using the Removal Tool from the 3-in-1 Core Tool.

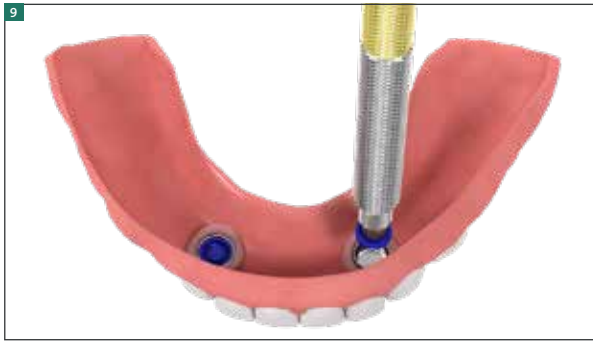

**Step 9:**

Place the selected Retention Insert into each Denture Cap using the Seating Tool from the 3-in-1 Core Tool. Start with the least retentive Inserts for the initial patient try-in.



**Step 10:**

Seat the overdenture and press down to engage the Attachments on the LOCATOR® Abutments and verify the occlusion. Instruct the patient on how to remove and insert the overdenture. If the retention is not satisfactory, remove the Inserts and replace with the next level of retention.

## 2.3 PROCESSING LOCATOR® DENTURE CAPS INTO THE OVERDENTURE: INDIRECT TECHNIQUE WITH LABORATORY PROCESSING

### 2.3.1 Conventional impression taking – abutment level

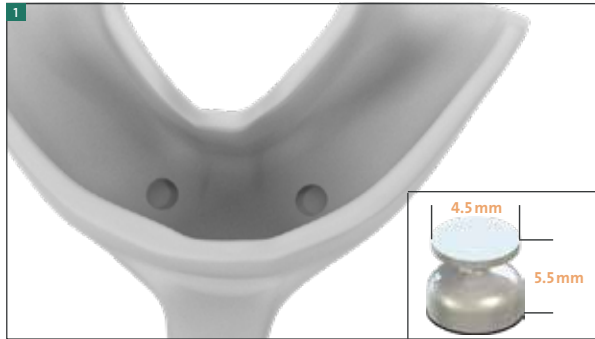

#### Step 1:

A stock or custom impression tray may be used. Ensure that each recess has enough space for the height of the LOCATOR Impression Copings.



#### Step 2:

Place a LOCATOR Impression Coping on each abutment and press down firmly. Syringe the impression material around the circumference of each coping. Fill the impression tray and insert it over the copings and onto the tissue. Allow the material to set and remove the impression tray. Send the cured impression to the dental laboratory.



#### Step 3:

Seat the appropriate diameter LOCATOR Analogs into each Impression Coping and verify that the Analogs are secure in the Impression copings.



#### Step 4:

Pour a plaster model.

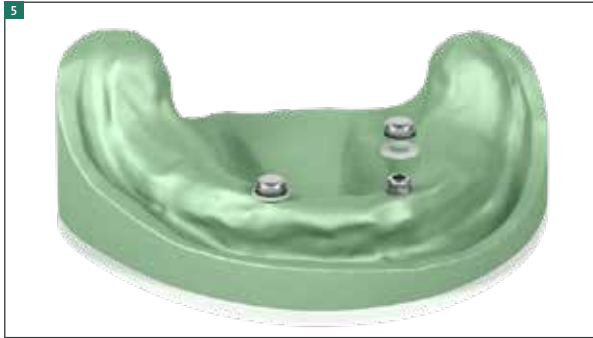

**Step 5:**

Place a White Block-Out Spacer around each LOCATOR® Analog and press it down to the plaster model. Snap a Denture Cap with a pre-assembled Black Processing Insert onto each Analog, pressing down firmly.

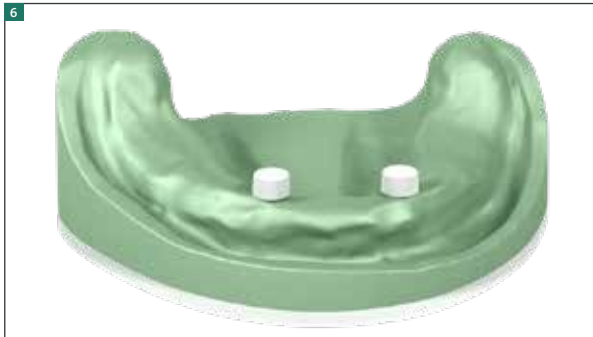

**Step 6:**

Optional Step: A LOCATOR Processing Spacer could be used instead of the Denture Caps during the fabrication of the overdenture. The Processing Spacer creates a recess in the overdenture base to allow for the Denture Cap to be seated without any interference with the surrounding overdenture acrylic.



**Step 7:**

Create and process the new overdenture according to standard lab procedures.

Remove the overdenture from the model, finish, and polish.

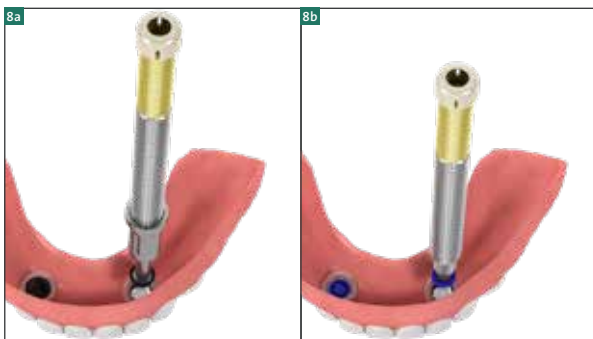

**Steps 8a and 8b:**

Remove the Black Processing Insert (a) using the Removal Tool from the 3-in-1 Core Tool.

Place the selected Retention Insert (b) into each Denture Cap using the Seating Tool from the 3-in-1 Core Tool. Start with the least retentive Insert for the initial patient try in.



**Step 9:**

Seat the overdenture and press down to engage the Attachments on the LOCATOR Abutments and verify the occlusion. Instruct the patient on how to remove and insert the overdenture. If the retention is not satisfactory, remove the Inserts and replace with the next level of retention.

### 2.3.2 Digital impression taking – abutment level



#### Step 1:

Place a LOCATOR® Scanbody on each LOCATOR Abutment and press down firmly.

Ensure that the seating surface of the abutment is clean, free of residue, and dry.



#### Step 2:

Proceed with scanning following the software prompts and hardware IFU.

When the scan is complete, the Scanbody needs to be removed, cleaned, and sterilized before it can be used on the next case.



#### Step 3:

Process the optical scan and send to the dental laboratory for the design and manufacturing of the final overdenture.

The LOCATOR Scanbody creates a recess in the overdenture base to allow for the Denture Cap to be seated without any interference with the surrounding overdenture acrylic.

Follow the direct technique for the processing of the LOCATOR® Denture Cap into the overdenture, described in section 2.2.

# 4. SPECIAL FEATURED LOCATOR<sup>®</sup> COMPONENTS

## LOCATOR RETENTION INSERTS

The LOCATOR Attachment System allows for a prosthetic insertion of up to  $\pm 20^\circ$  divergence, meaning  $40^\circ$  between two LOCATOR Abutments.

**Note:** It is recommended to use the light retention force first. If it feels too loose for the patient, exchange with inserts with a higher retention force.

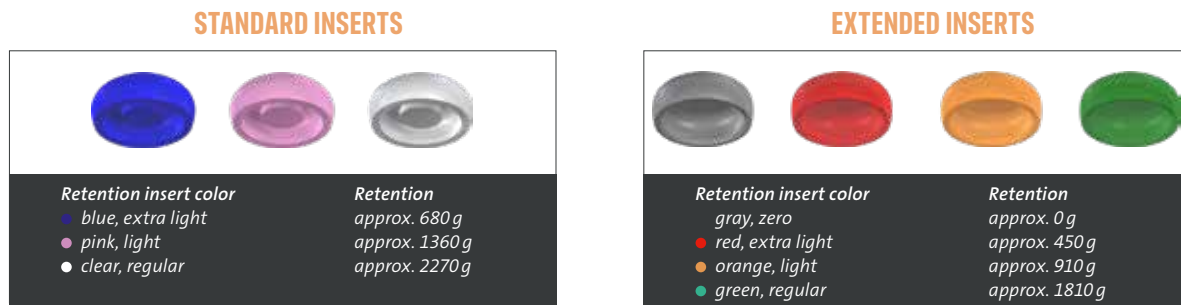

The LOCATOR Attachment system offers two ranges of retention Inserts.

The Standard Inserts have a dual retention to maximize stability and pivoting action, compensate up to  $20^\circ$  divergence between two implants.

The Extended range Inserts accommodates up to  $40^\circ$  of total divergence between two implants.



### **LOCATOR® Processing Spacer**

The LOCATOR Processing Spacer is a placeholder for the Denture Cap. It is used for the model-cast, cast metal-reinforced denture, or if the Denture Cap is to be polymerized into the overdenture chair-side.



### **LOCATOR Block-out Spacer**

The Block-out Spacer blocks out the area surrounding the LOCATOR abutment, preventing resin or a bonding agent from flowing into the Denture Cap and embedding the abutment.



### **LOCATOR Black Processing Male**

The LOCATOR Processing Insert protects the interior of the Denture Cap and keeps it in place during processing. Furthermore, it also prevents any resin or bonding agent from entering into the Denture Cap during fixation.



### **LOCATOR Abutment Holder Sleeve**

The LOCATOR Abutment Holder Sleeve is designed for use with the Core Tool when placing an abutment in the mouth. This Abutment Holder Sleeve prevents the LOCATOR Abutment from falling off the Abutment Driver when transferring it into the implant.





### **LOCATOR Scanbody**





Scanbodies can be used intraorally or in a lab setting, saving time and improving efficiency in the digital process by accurately capturing the precise location of the LOCATOR Abutment, creating a perfect recess to allow for the Denture Cap to be seated without any interference.

# 5. PRODUCT REFERENCE LIST

## 5.1 LOCATOR® ABUTMENTS

Product	Image	Description	Material	Art.-No.
<b>LOCATOR Abutments</b>				
NNC LOCATOR Abutment		Height 1 mm	TAV/TiN	048.581
		Height 2 mm		048.582
		Height 3 mm		048.583
		Height 4 mm		048.584
		Height 5 mm		048.585
		Height 6 mm		048.586
RN LOCATOR Abutment		Height 1 mm	TAV/TiN	048.175
		Height 2 mm		048.176
		Height 3 mm		048.177
		Height 4 mm		048.178
		Height 5 mm		048.179
		Height 6 mm		048.180
WN LOCATOR Abutment		Height 1 mm	TAV/TiN	048.183
		Height 2 mm		048.184
		Height 3 mm		048.185
		Height 4 mm		048.186
		Height 5 mm		048.187
NC LOCATOR Abutment		Height 2 mm	TAV/TiN	022.2502
		Height 3 mm		022.2503
		Height 4 mm		022.2504
		Height 5 mm		022.2505
		Height 6 mm		022.2506
RC LOCATOR Abutment		Height 1 mm	TAV/TiN	022.4501
		Height 2 mm		022.4502
		Height 3 mm		022.4503
		Height 4 mm		022.4504
		Height 5 mm		022.4505
		Height 6 mm		022.4506





Product	Image	Description	Material	Art.-No.
<b>LOCATOR® Abutments</b>				
RB/WB LOCATOR Abutment		Height 1.5 mm	TAV/TiN	062.5033
		Height 2.5 mm		062.5034
		Height 3.5 mm		062.5035
		Height 4.5 mm		062.5036
		Height 5.5 mm		062.5037
		Height 6.5 mm		062.5038
NT LOCATOR Abutment		Height 1 mm	TAV/TiN	062.5039
		Height 2 mm		062.5040
		Height 3 mm		062.5041
		Height 4 mm		062.5042
		Height 5 mm		062.5043
		Height 6 mm		062.5044
RT LOCATOR Abutment		Height 1 mm	TAV/TiN	062.5045
		Height 2 mm		062.5046
		Height 3 mm		062.5047
		Height 4 mm		062.5048
		Height 5 mm		062.5049
		Height 6 mm		062.5050
WT LOCATOR Abutment		Height 1 mm	TAV/TiN	062.5051
		Height 2 mm		062.5052
		Height 3 mm		062.5053
		Height 4 mm		062.5054
		Height 5 mm		062.5055
		Height 6 mm		062.5056

Product	Image	Description	Material	Art.-No.
<b>LOCATOR® Bar Abutments</b>				
LOCATOR Bar Abutment		M2 Thread (2.0 mm), height 1.78 mm, packaging 2 pieces	TAV/TiN	048.804V2

## 5.2 LOCATOR® COMPONENTS

Product	Image	Description	Material	Art.-No.
<b>Impression-taking/Master Cast Fabrication</b>				
LOCATOR Impression Coping		Height 4 mm, packaging 4 pieces	Al housing with LDPE insert	048.197V4
LOCATOR Female Analog		Length 10 mm, Ø4 mm, packaging 4 pieces, for the connections NC, RC, RB/WB, NNC, NT	Al	025.0120-04
LOCATOR Female Analog		Length 10 mm, Ø5 mm, for the connections RN, WN, RT, WT	Al	048.198V4
LOCATOR Scanbody		LOCATOR® Scanbody, 2 pieces	PEEK	062.5057V2
		LOCATOR® Scanbody, 4 pieces		062.5057V4
		LOCATOR® Scanbody, 10 pieces		062.5057V10
<b>Lab Set, up to 20° Divergence Compensation</b>				
LOCATOR Attachment Processing Package		Includes: Denture Cap (Ø5.5 mm, height 2.5 mm) with black Processing Insert (048.195) Block-out Spacer (048.196) Clear Retention Insert (048.190) Pink Retention Insert (048.191) Blue Retention Insert (048.192) Packaging 2 pieces	Ti/Nylon/LDPE/Silicone	048.189V2
LOCATOR standard Retention Inserts		Clear, angulation 0°–10°, Regular Retention approx. 2270g, packaging 4 pieces	Nylon	048.190V4
		Pink, angulation 0°–10°, Light Retention approx. 1360g, packaging 4 pieces		048.191V4
		Blue, angulation 0°–10°, Extra Light Retention approx. 680g, packaging 4 pieces		048.192V4
<b>Lab Set, up to 40° Divergence Compensation</b>				
LOCATOR Attachment Processing Package		Includes: Denture Cap (Ø5.5 mm, height 2.5 mm) with black Processing Insert (048.195) Block-out Spacer (048.196) Green Retention Insert (048.193) Orange Retention Insert (048.188) Red Retention Insert (048.194) Packaging 2 pieces	Ti/Nylon/LDPE/Silicone	048.182V2
LOCATOR Extended range Retention Inserts.		Green, angulation 10°–20°, Regular Retention approx. 1810g, packaging 4 pieces	Nylon	048.193V4
		Orange, angulation 10°–20°, Light Retention approx. 910g, packaging 4 pieces		048.188V4
		Red, angulation 10°–20°, Extra Light Retention approx. 450g, packaging 4 pieces		048.194V4
		Gray, angulation 10°–20°, Zero Retention approx. 0g, packaging 4 pieces		048.181V4

Product	Image	Description	Material	Art.-No.
<b>LOCATOR® for Bars</b>				
LOCATOR Bar Attachment Processing Package		Includes: Denture Cap (Ø5.5 mm, height 2.5 mm) with yellow Processing Insert Block-out Spacer (048.196) Clear Retention Insert (048.190) Pink Retention Insert (048.191) Blue Retention Insert (048.192) Packaging 10 pieces	Ti/Nylon/LDPE/ Silicone	048.805V10
		Includes: Denture Cap (Ø5.5 mm, height 2.5 mm) with yellow Processing Insert Block-out Spacer (048.196) Clear Retention Insert (048.190) Pink Retention Insert (048.191) Blue Retention Insert (048.192) Packaging 2 pieces		048.805V2
<b>LOCATOR® Tools and Auxiliary Parts</b>				
LOCATOR Parallel Post		Length 8 mm, packaging 4 pieces	LDPE	048.199V4
LOCATOR Processing Insert		Black, packaging 4 pieces		048.195V4
LOCATOR Block-out Spacer		Thickness 0.4 mm, packaging 20 pieces	Silicone	048.196V20
LOCATOR Processing Spacer		5.40 mm width x 1.90 mm height, packaging 4 pieces	POM	048.218V4
LOCATOR Core Tool		Three-part, length 100 mm	Stainless steel	046.415
LOCATOR Core Tool Tip		LOCATOR® Core Tool replacement tip		046.414
LOCATOR Abutment Holder Sleeve		LOCATOR® Abutment Holder Sleeve, packaging 4 pieces	PEEK	046.413V4
LOCATOR Driver		For Ratchet, short, length 15 mm		046.416
		For Ratchet, long, length 21 mm		046.417
LOCATOR Angle Measurement Guide		Length 50 mm, width 15 mm		048.200

**Straumann North American Headquarters**

Straumann USA, LLC

60 Minuteman Road

Andover, MA 01810

Phone 800/448 8168 (US) · 800/363 4024 (CA)

Fax 978/747 2490

[www.straumann.us](http://www.straumann.us) · [www.straumann.ca](http://www.straumann.ca)

[ifu.straumann.com](http://ifu.straumann.com)

© Straumann USA, LLC 2023. All rights reserved.

Straumann® and/or other trademarks and logos from Straumann® that are mentioned herein are the trademarks or registered trademarks of Straumann Holding AG and/or its affiliates. All rights reserved.

